

-----'S

**MATH  
REFERENCE  
FOLDER**

## MULTIPLICATION CHART - 12 X 12

x	1	2	3	4	5	6	7	8	9	10	11	12
1	1	2	3	4	5	6	7	8	9	10	11	12
2	2	4	6	8	10	12	14	16	18	20	22	24
3	3	6	9	12	15	18	21	24	27	30	33	36
4	4	8	12	16	20	24	28	32	36	40	44	48
5	5	10	15	20	25	30	35	40	45	50	55	60
6	6	12	18	24	30	36	42	48	54	60	66	72
7	7	14	21	28	35	42	49	56	63	70	77	84
8	8	16	24	32	40	48	56	64	72	80	88	96
9	9	18	27	36	45	54	63	72	81	90	99	108
10	10	20	30	40	50	60	70	80	90	100	110	120
11	11	22	33	44	55	66	77	88	99	110	121	132
12	12	24	36	48	60	72	84	96	108	120	132	144

# MULTIPLICATION CHART - 25 X 25

x	1	2	3	4	5	6	7	8	9	10	11	12	13	14	15	16	17	18	19	20	21	22	23	24	25
1	1	2	3	4	5	6	7	8	9	10	11	12	13	14	15	16	17	18	19	20	21	22	23	24	25
2	2	4	6	8	10	12	14	16	18	20	22	24	26	28	30	32	34	36	38	40	42	44	46	48	50
3	3	6	9	12	15	18	21	24	27	30	33	36	39	42	45	48	51	54	57	60	63	66	69	72	75
4	4	8	12	16	20	24	28	32	36	40	44	48	52	56	60	64	68	72	76	80	84	88	92	96	100
5	5	10	15	20	25	30	35	40	45	50	55	60	65	70	75	80	85	90	95	100	105	110	115	120	125
6	6	12	18	24	30	36	42	48	54	60	66	72	78	84	90	96	102	108	114	120	126	132	138	144	150
7	7	14	21	28	35	42	49	56	63	70	77	84	91	98	105	112	119	126	133	140	147	154	161	168	175
8	8	16	24	32	40	48	56	64	72	80	88	96	104	112	120	128	136	144	152	160	168	176	184	192	200
9	9	18	27	36	45	54	63	72	81	90	99	108	117	126	135	144	153	162	171	180	189	198	207	216	225
10	10	20	30	40	50	60	70	80	90	100	110	120	130	140	150	160	170	180	190	200	210	220	230	240	250
11	11	22	33	44	55	66	77	88	99	110	121	132	143	154	165	176	187	198	209	220	231	242	253	264	275
12	12	24	36	48	60	72	84	96	108	120	132	144	156	168	180	192	204	216	228	240	252	264	276	288	300
13	13	26	39	52	65	78	91	104	117	130	143	156	169	182	195	208	221	234	247	260	273	286	299	312	325
14	14	28	42	56	70	84	98	112	126	140	154	168	182	196	210	224	238	252	266	280	294	308	322	336	350
15	15	30	45	60	75	90	105	120	135	150	165	180	195	210	225	240	255	270	285	300	315	330	345	360	375
16	16	32	48	64	80	96	112	128	144	160	176	192	208	224	240	256	272	288	304	320	336	352	368	384	400
17	17	34	51	68	85	102	119	136	153	170	187	204	221	238	255	272	289	306	323	340	357	374	391	408	425
18	18	36	54	72	90	108	126	144	162	180	198	216	234	252	270	288	306	324	342	360	378	396	414	432	450
19	19	38	57	76	95	114	133	152	171	190	209	228	247	266	285	304	323	342	361	380	399	418	437	456	475
20	20	40	60	80	100	120	140	160	180	200	220	240	260	280	300	320	340	360	380	400	420	440	460	480	500
21	21	42	63	84	105	126	147	168	189	210	231	252	273	294	315	336	357	378	399	420	441	462	483	504	525
22	22	44	66	88	110	132	154	176	198	220	242	264	286	308	330	352	374	396	418	440	462	484	506	528	550
23	23	46	69	92	115	138	161	184	207	230	253	276	299	322	345	368	391	414	437	460	483	506	529	552	575
24	24	48	72	96	120	144	168	192	216	240	264	288	312	336	360	384	408	432	456	480	504	528	552	576	600
25	25	50	75	100	125	150	175	200	225	250	275	300	325	350	375	400	425	450	475	500	525	550	575	600	625

# CM GRID PAPER

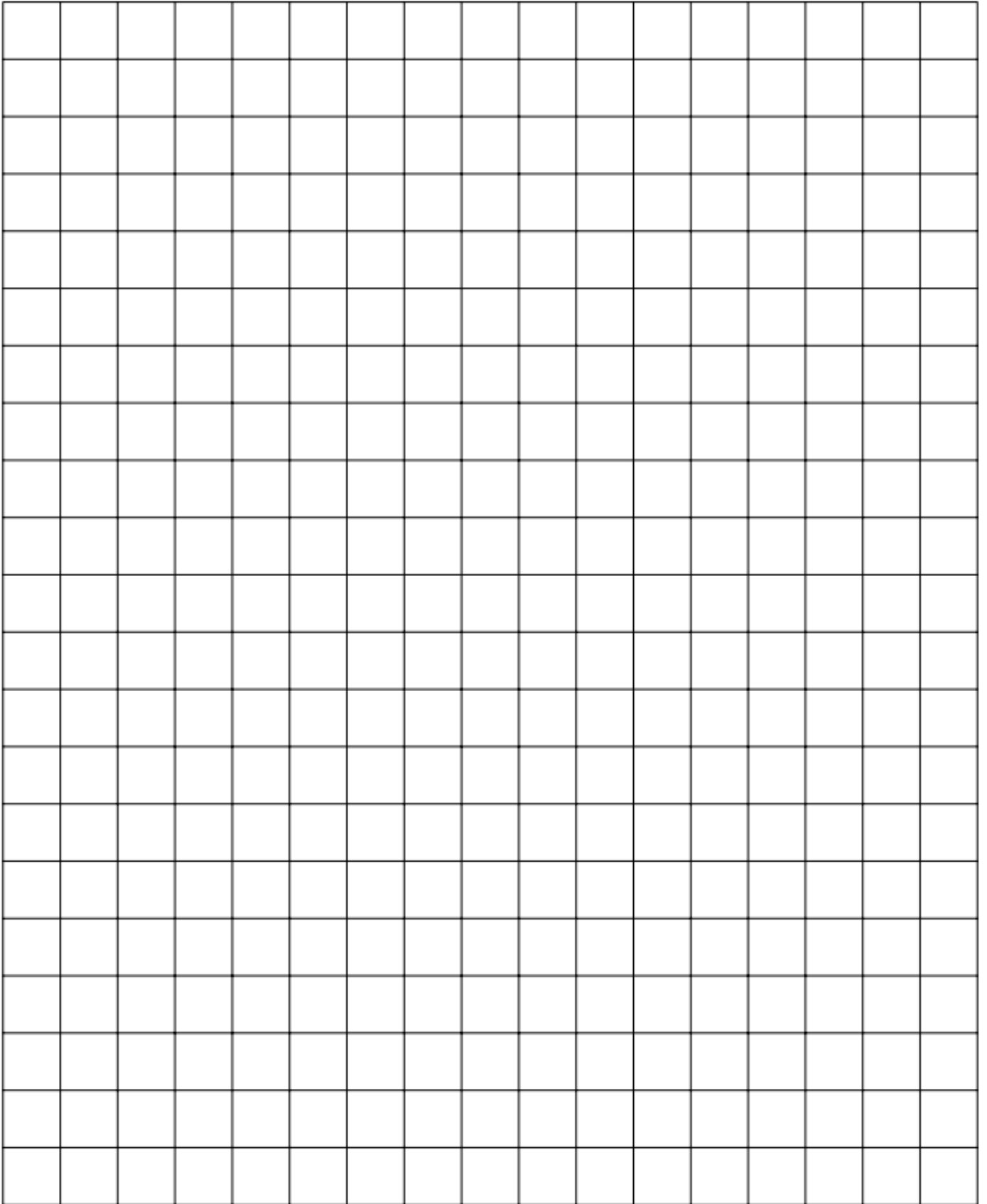

# PLACE VALUE CHART

BILLIONS	MILLIONS			THOUSANDS			ONES			DECIMALS		
one	hundred	ten	one	hundred	ten	one	hundreds	tens	ones	tenths	hundredths	thousandths

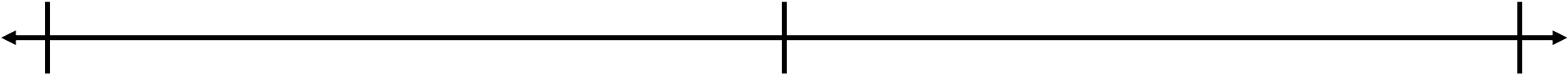

> greater than	= equal to	< less than
----------------	------------	-------------

# SUBTRACTION WITH REGROUPING

Standard Algorithm

$$\begin{array}{r}
 \phantom{0}9\phantom{0}13 \\
 3\phantom{0}\cancel{10}\phantom{0}\cancel{3}12 \\
 \hline
 \cancel{4}\phantom{0}\cancel{4}\cancel{2} \\
 2,253 \\
 \hline
 1,789
 \end{array}$$

Workspace

Base 10 Blocks

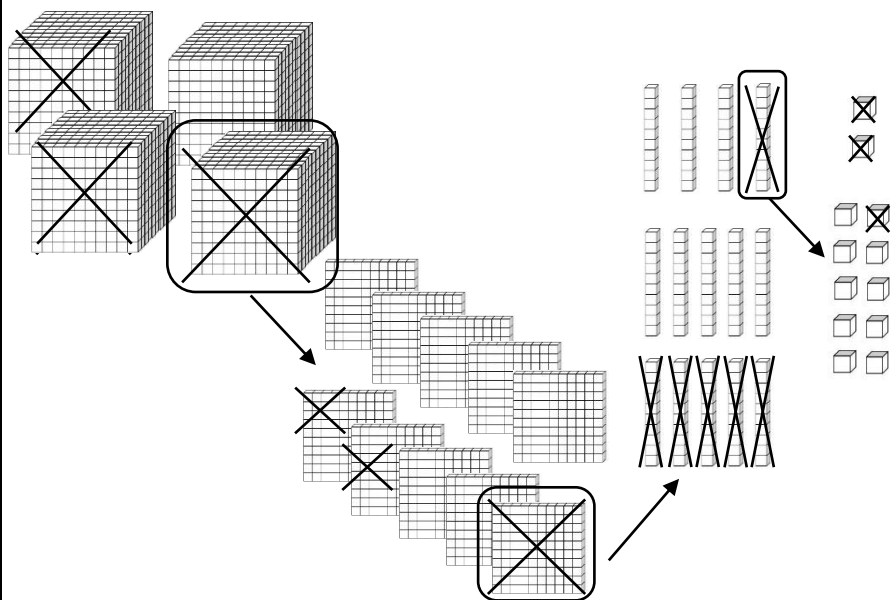

# DECIMALS

## REFERENCE SHEET

Place Value Chart

hundred millions	ten millions	millions	hundred thousands	ten thousands	thousands	hundreds	tens	ones	decimal	tenths	hundredths	thousandths
									•			

Hundredth Grids

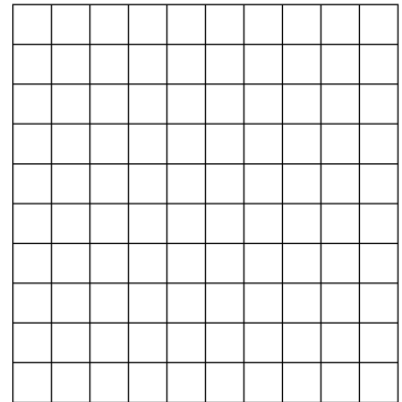
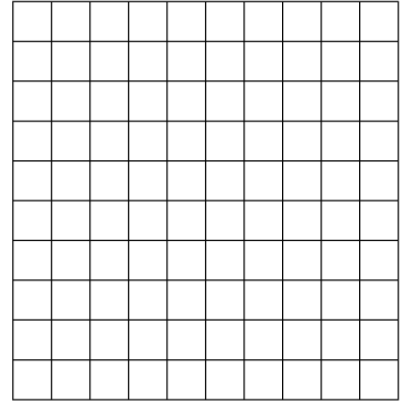

Standard Form

456.89

Workspace:

Word Form

Four hundred fifty-six and eighty-nine hundredths

Workspace:

Expanded Form

$400 + 50 + 6 + 0.8 + 0.09$

Workspace:

Expanded Notation

$(4 \times 100) + (5 \times 10) + (6 \times 1) + (8 \times 0.1) + (9 \times 0.01)$   
 or  
 $(4 \times 100) + (5 \times 10) + (6 \times 1) + (8 \times \frac{1}{10}) + (9 \times \frac{1}{100})$

Workspace:

# MULTIPLICATION REFERENCE SHEET

$$5,648 \times 3$$

$$\begin{array}{r} \phantom{1} \phantom{1} \phantom{2} \\ 5,648 \\ \times \phantom{00} 3 \\ \hline 16,944 \end{array}$$

$$43 \times 25$$

$$\begin{array}{r} \phantom{1} \\ 43 \\ \times 25 \\ \hline 215 \\ + 860 \\ \hline 1,075 \end{array}$$

$$495 \times 34$$

$$\begin{array}{r} \phantom{1} \phantom{2} \phantom{1} \\ \cancel{4} \cancel{9} \cancel{5} \\ \phantom{0} 495 \\ \times \phantom{00} 34 \\ \hline \phantom{1,} 980 \\ + 14,850 \\ \hline 16,830 \end{array}$$



# DIVISION REFERENCE SHEET

PARTIAL QUOTIENTS STRATEGY

$$\begin{array}{r} 118 \frac{14}{36} \\ 36 \overline{) 4,262} \\ \underline{-3,600} \quad 36 \times 100 \\ 662 \\ \underline{-360} \quad 36 \times 10 \\ 302 \\ \underline{-288} \quad 36 \times 8 \\ 14 \end{array}$$

MULTIPLICATION CHECK

$$\begin{array}{r} 118 \\ \times 36 \\ \hline 708 \\ + 3,540 \\ \hline 4,248 \\ + 14 \\ \hline 4,262 \end{array}$$

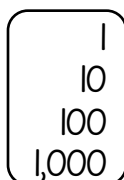

WORKSPACE:

MULTIPLICATION CHECK:

# COORDINATE PLANE REFERENCE SHEET

This is a COORDINATE PLANE, as known as a COORDINATE GRID.

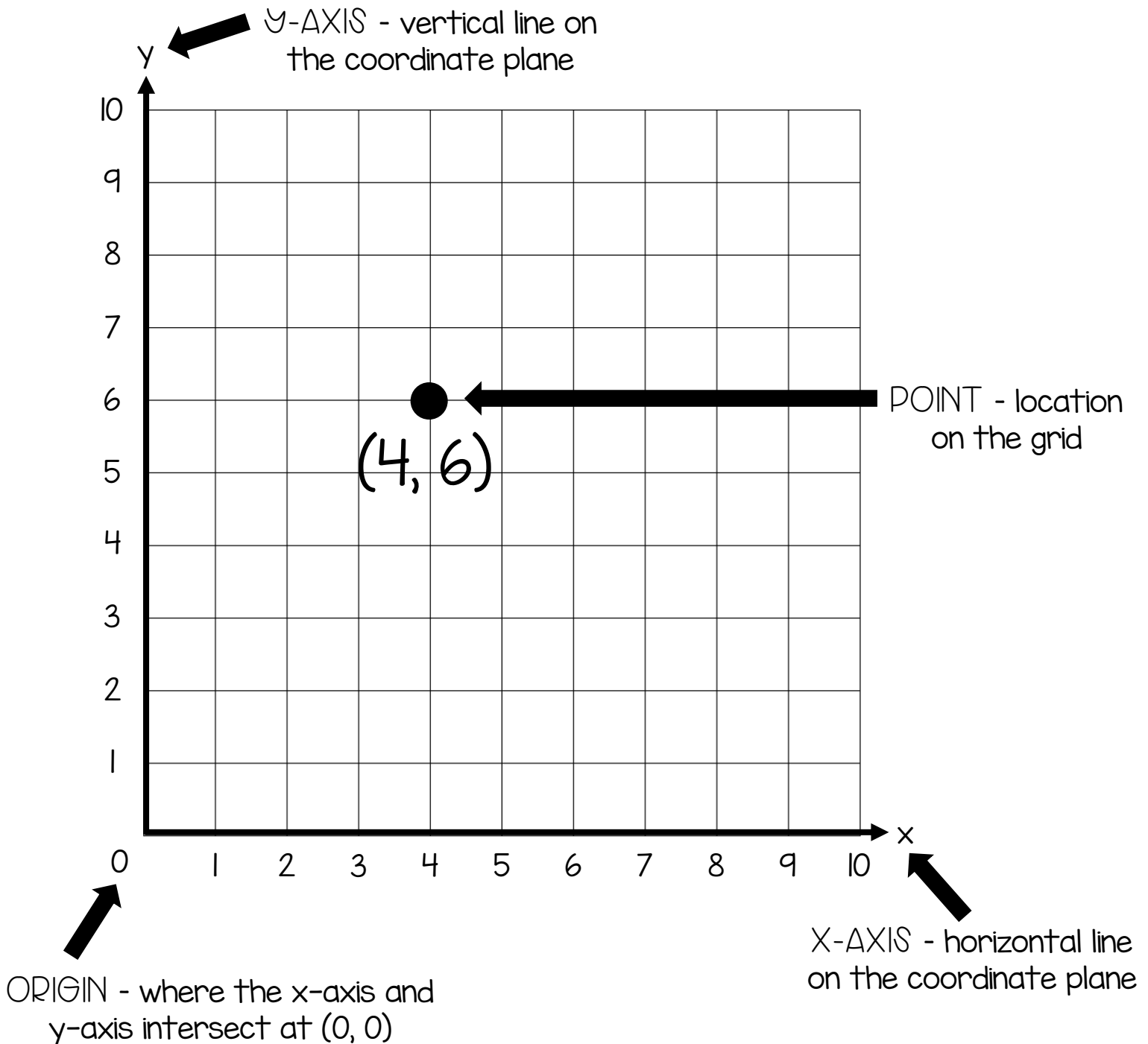

ORDERED PAIR - names a point on the coordinate grid as (X, Y)



(x, y)  
(4, 6)

\*starting at the origin, go to the right 4 spaces and up six spaces to locate the point on the grid\*

# EXPRESSIONS VOCABULARY

## ADDITION

increase    combine    added to  
more than    plus    add  
and    gain    both  
more    sum    join  
total    in all    altogether

## SUBTRACTION

minus    subtract  
fewer    take away  
left    remaining  
less    decrease  
less than    deduct  
difference

## MULTIPLICATION

each group    product  
multiply    groups of  
double    times  
triple    multiplied by  
twice    product of

## DIVISION

divided by    fraction  
half    share  
quotient    in all  
split    shared equally

# EXPRESSIONS REFERENCE SHEET

What's the difference?

EXPRESSION:

- An expression is a mathematical phrase combining numbers using operations.
- NO equals sign

EQUATION:

- A mathematical statement containing an equals sign, to show that two expressions are equal

Solving an expression step-by-step:



Parenthesis

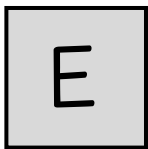

Exponents



Multiplication/Division  
\*from left to right\*

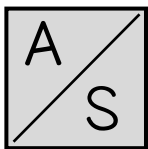

Addition/Subtraction  
\*from left to right\*

$$8 \div 2 - 3 + (2 \times 4)$$

$$8 \div 2 - 3 + 8$$

$$4 - 3 + 8$$

$$1 + 8$$

$$9$$

Representing Expressions with Words:

Add 5 and 6, then multiply by 3

$$(5 + 6) \times 3$$

Subtract 45 from 90, then divide by 3

$$(90 - 45) \div 3$$

# ADDING & SUBTRACTING DECIMALS REFERENCE SHEET

\*I CAN add and subtract decimals by lining up place values\*

$$24.5 + 2.79$$

$$\begin{array}{r} | \\ 24.5\boxed{0} \\ + 2.79 \\ \hline 27.29 \end{array}$$

$$12 - 3.68$$

$$\begin{array}{r} | | \quad | \\ 12.00 \\ - 3.68 \\ \hline 8.32 \end{array}$$

Workspace:

# MULTIPLYING DECIMALS REFERENCE SHEET

\*I CAN multiply decimals by using decimal squares to model\*

Decimal x Whole Number

$$0.21 \times 3 = 0.63$$

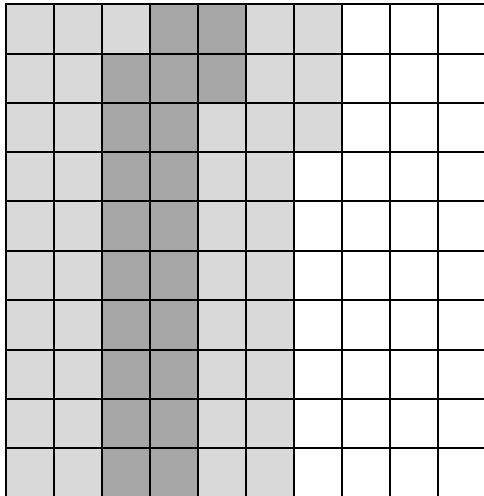

Decimal x Decimal

$$0.4 \times 0.6 = 0.24$$

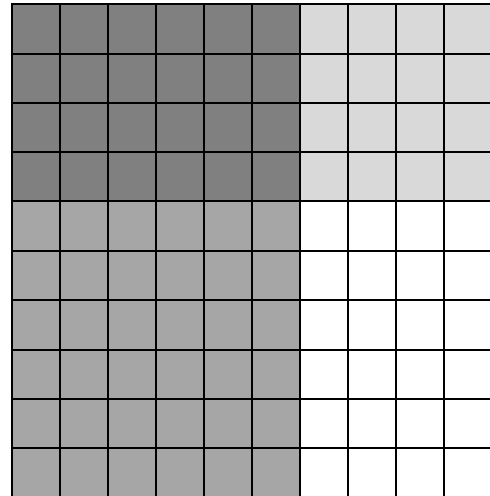

Workspace:

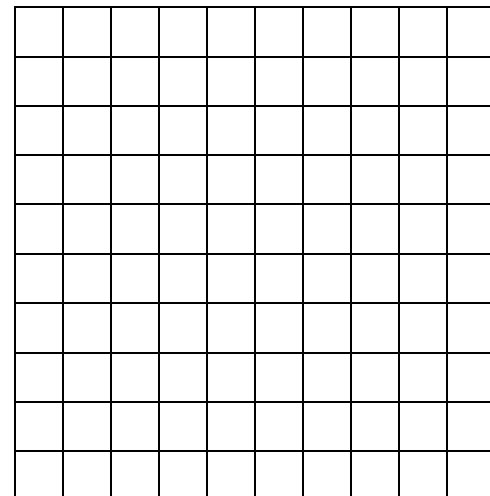
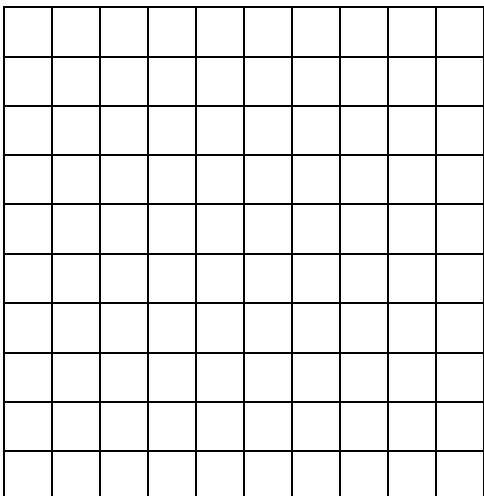



# TRIANGLES CLASSIFIED BY...

SIDES:

## EQUILATERAL

All 3 sides are equal.

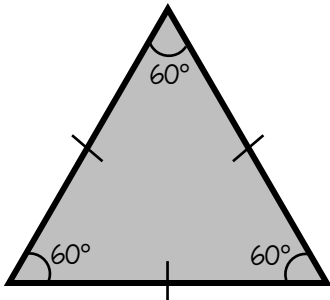

ANGLES:

## ACUTE

All 3 angles are acute.

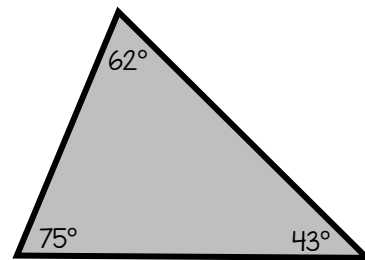

## ISOSCELES

2 sides are equal.

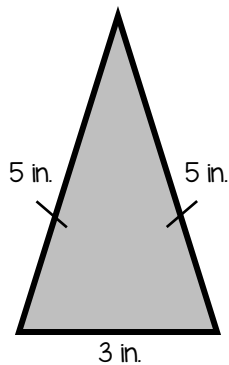

## RIGHT

Has 1 right angle.

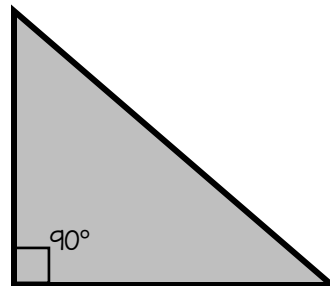

## SCALENE

No equal sides.

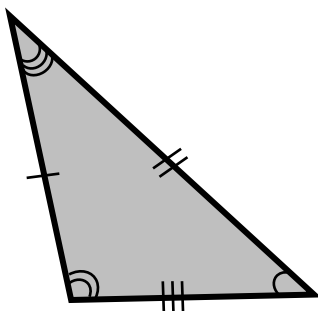

## OBTUSE

Has 1 obtuse angle.

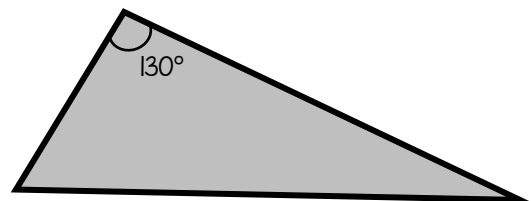



# QUADRILATERAL FAMILY TREE

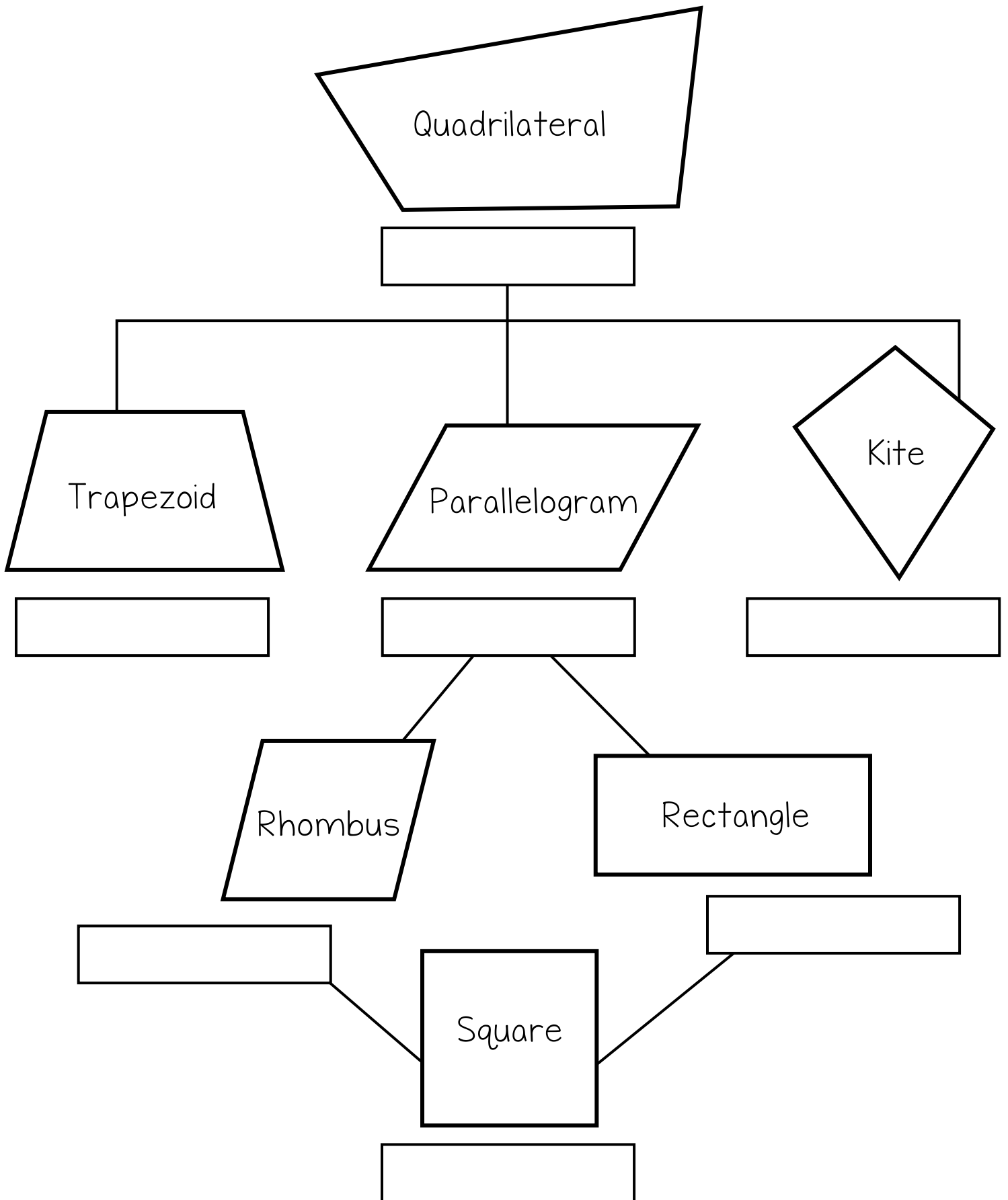

# QUADRILATERAL FAMILY TREE CUTOUTS

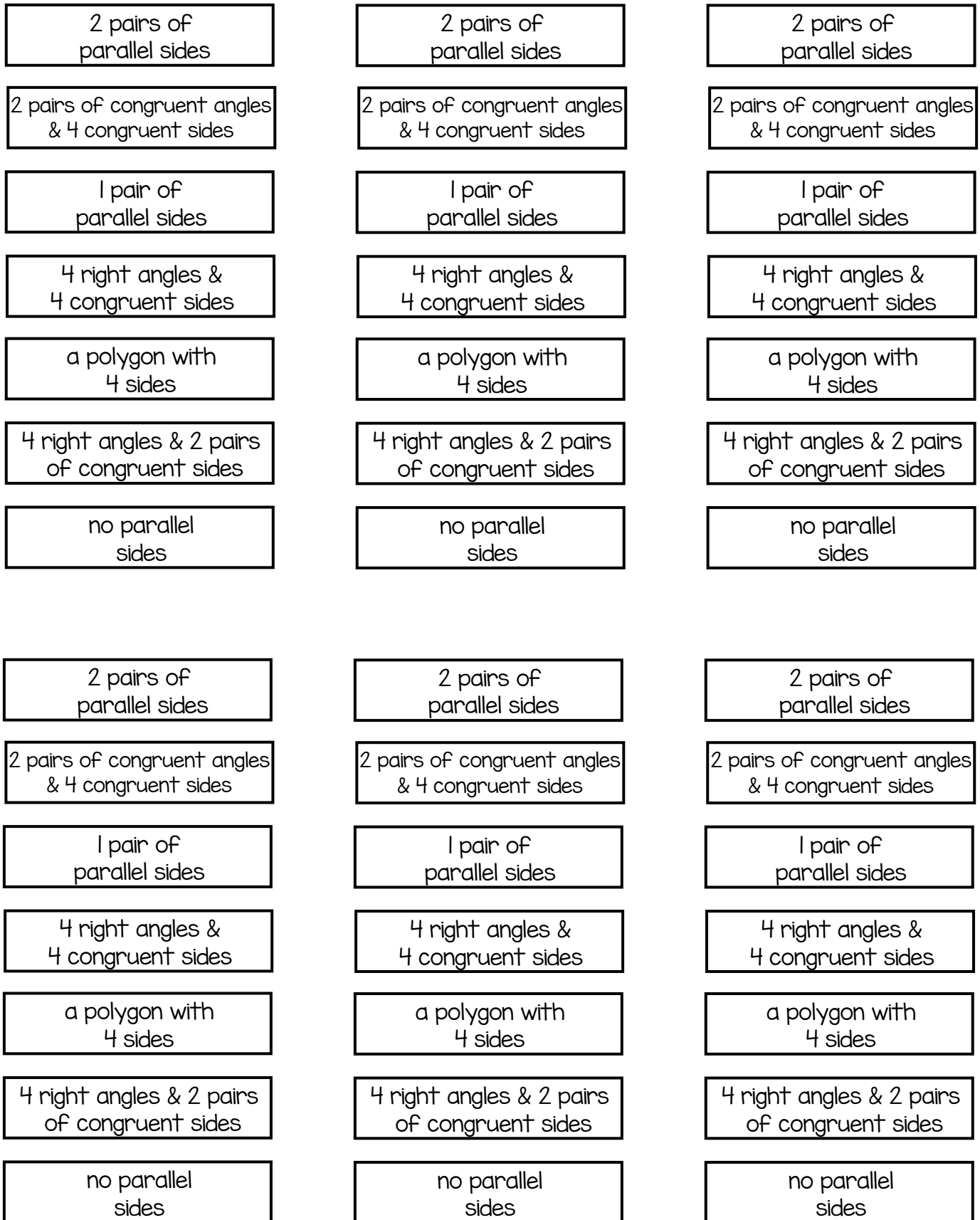

# VOLUME REFERENCE SHEET

VOLUME is the amount of space occupied by a 3-dimensional object, measured in cubic units.

## VOLUME FORMULA

$$V = L \times W \times H$$

$$V = 8 \times 2 \times 4$$

$$V = 64 \text{ inches cubed}$$

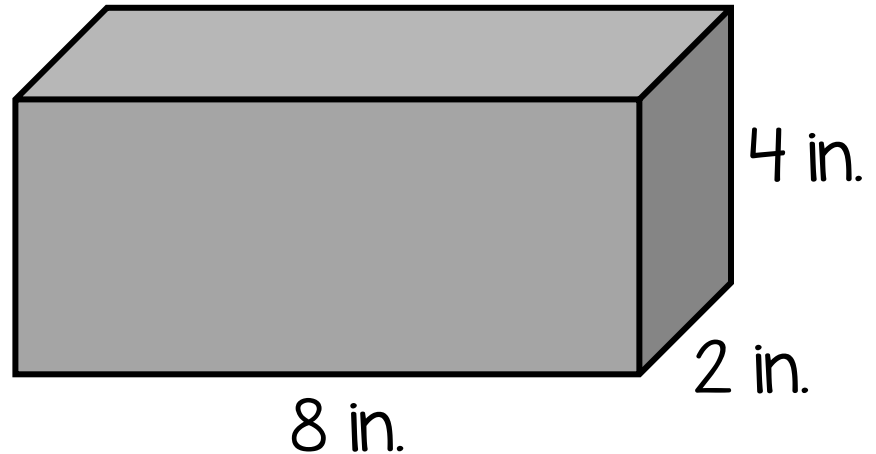

HOW TO FIND VOLUME OF AN IRREGULAR SHAPE:

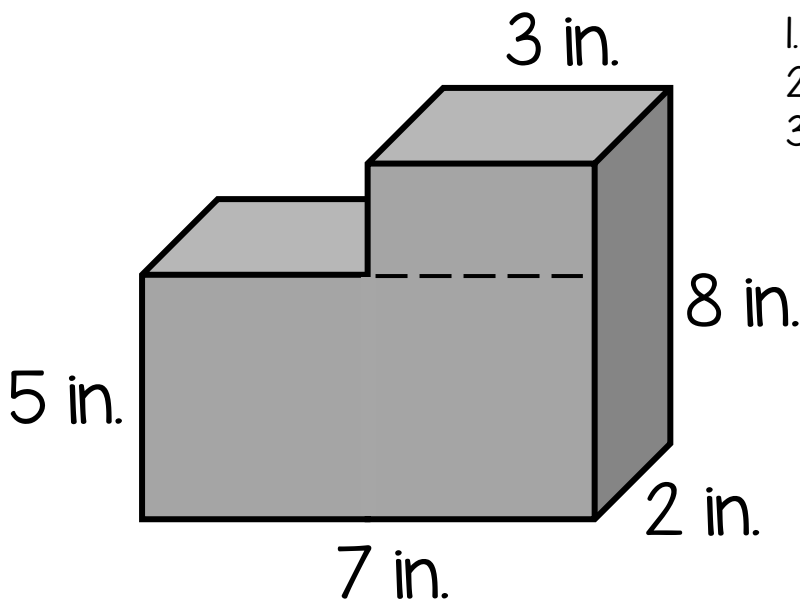

1. Partition the shape.
2. Find volume of all rectangular prisms.
3. Add your volumes together.

$$\begin{array}{ll} V = L \times W \times H & V = L \times W \times H \\ V = 5 \times 7 \times 2 & V = 3 \times 3 \times 2 \\ V = 70 \text{ inches cubed} & V = 18 \text{ inches cubed} \end{array}$$

$$V = 70 + 18 = 88 \text{ inches cubed}$$

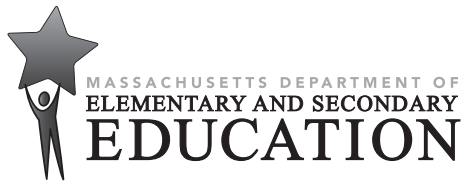

## Massachusetts Comprehensive Assessment System Grade 5 Mathematics Reference Sheet

---

### CONVERSIONS

1 cup = 8 fluid ounces

1 pint = 2 cups

1 quart = 2 pints

1 gallon = 4 quarts

1 mile = 5280 feet

1 mile = 1760 yards

1 pound = 16 ounces

1 ton = 2000 pounds

### AREA (A) FORMULAS

square . . . . .  $A = s \times s$

( $s$  = length of a side)

rectangle . . . . .  $A = b \times h$

( $b$  = length of base;  $h$  = height)

OR

$A = l \times w$

( $l$  = length;  $w$  = width)

### VOLUME (V) FORMULAS

right rectangular prism . . . . .  $V = l \times w \times h$

( $l$  = length;  $w$  = width;  $h$  = height)

OR

$V = B \times h$

( $B$  = area of base;  $h$  = height)

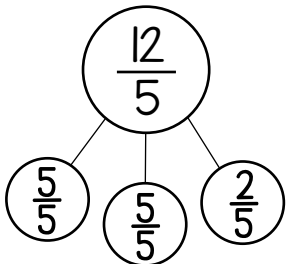
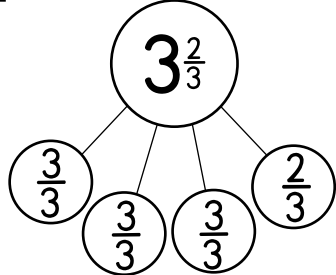

## GENERATING MIXED NUMBERS AND FRACTIONS GREATER THAN ONE

$\frac{12}{5} = 2\frac{2}{5}$ 	$\frac{17}{4} =$
$3\frac{2}{3} = \frac{11}{3}$ 	$3\frac{2}{6} =$

## GENERATING EQUIVALENT FRACTIONS

Multiplying by 1 whole:

$\frac{2}{3} \times 1\frac{3}{3} = \frac{6}{9}$	$\frac{5}{6} \times 1\frac{\quad}{\quad} = \frac{\quad}{\quad}$
---	---

Dividing by 1 whole:

$\frac{4}{6} \div 1\frac{2}{2} = \frac{2}{3}$	$\frac{4}{12} \div 1\frac{\quad}{\quad} = \frac{\quad}{\quad}$
---	--

# ADDING & SUBTRACTING FRACTIONS REFERENCE SHEET

## ADDITION

$$2\frac{5}{6} + 1\frac{5}{8} = \boxed{4\frac{11}{24}}$$

$$\frac{5}{6} \times \frac{4}{4} = \frac{20}{24}$$

$$\frac{5}{8} \times \frac{3}{3} = \frac{15}{24}$$

$$\begin{array}{r} 2\frac{20}{24} \\ + 1\frac{15}{24} \\ \hline 3\frac{35}{24} = 4\frac{11}{24} \end{array}$$

## SUBTRACTION

$$3\frac{1}{3} - 1\frac{3}{4} = \boxed{1\frac{1}{2}}$$

$$\frac{1}{3} \times \frac{4}{4} = \frac{4}{12}$$

$$\frac{3}{4} \times \frac{3}{3} = \frac{9}{12}$$

$$\begin{array}{r} 2\frac{4}{12} \\ - 1\frac{9}{12} \\ \hline 1\frac{6}{12} = 1\frac{1}{2} \end{array}$$

WORKSPACE:

WORKSPACE:

# MULTIPLYING FRACTIONS REFERENCE SHEET

FRACTION X FRACTION

$$\frac{5}{6} \times \frac{4}{8} = \frac{20}{48}$$

$$\frac{20}{48} \div \frac{4}{4} = \boxed{\frac{5}{12}}$$

FRACTION X WHOLE NUMBER

$$3 \times \frac{4}{10} =$$

$$\frac{3}{1} \times \frac{4}{10} = \frac{12}{10}$$

$$\frac{12}{10} \div \frac{2}{2} = \boxed{\frac{6}{5} \text{ or } 1 \frac{1}{5}}$$

MIXED NUMBER X MIXED NUMBER

$$2 \frac{2}{3} \times 1 \frac{1}{4} =$$

$$\frac{8}{3} \times \frac{5}{4} = \frac{40}{12}$$

$$\frac{40}{12} \div \frac{4}{4} = \boxed{\frac{10}{3} \text{ or } 3 \frac{1}{3}}$$

WORKSPACE:



# DIVIDING FRACTIONS REFERENCE SHEET

WHOLE NUMBER  $\div$  FRACTION

$$4 \div \frac{1}{4} = 16$$

How many  $\frac{1}{4}$  pieces are in 4 wholes?

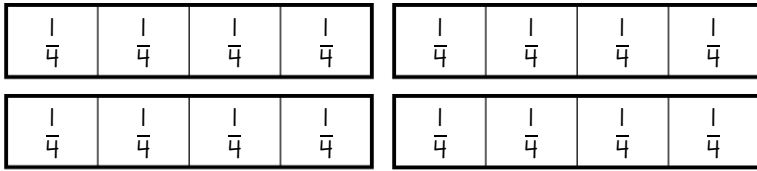

FRACTION  $\div$  WHOLE NUMBER

$$\frac{1}{2} \div 4 = \frac{1}{8}$$

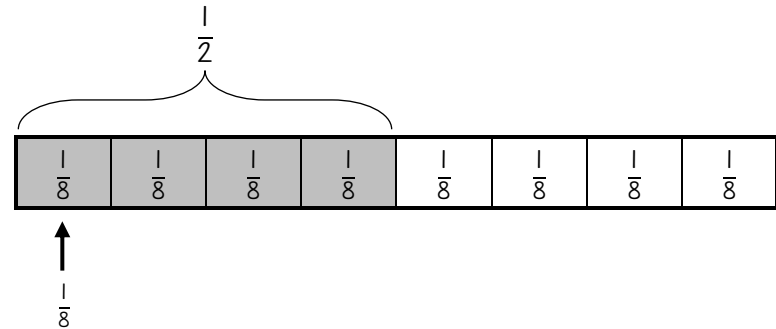

WORKSPACE: